

SUPPORTING HINGE FOR DOORS

LOIRA +

LOIRA + V.

LOIRA + T.R.

 Made in Italy

fapim[®]

Life in evolution

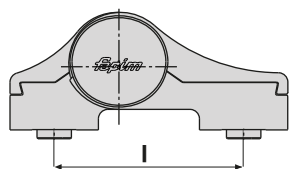
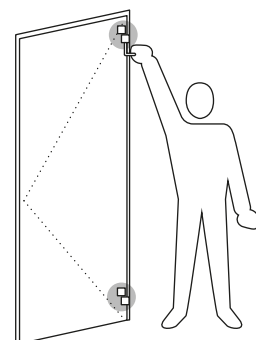
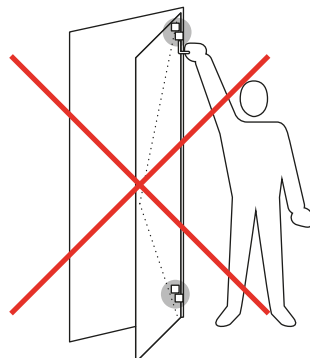
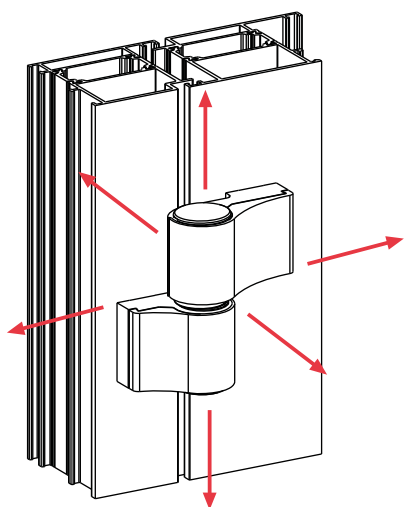

LOIRA + LOIRA + V.



41 ≤ l ≤ 99

CE 0333
EN 1935:02
4 7 7 0 1 4 1 14

160 Kg

l=106

CE 0333
EN 1935:02
4 7 6 0 1 4 1 13

120 Kg

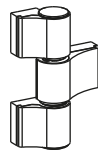

41 ≤ l ≤ 99

CE 0333
EN 1935:02
4 7 7 0 1 4 0 14

160 Kg

l=106

CE 0333
EN 1935:02
4 7 6 0 1 4 0 13

120 Kg

LOIRA + T.R.

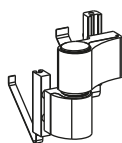

53 - 60

CE 0333
EN 1935:02
4 7 5 0 1 4 1 12

100 Kg

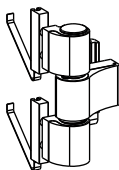

53

CE 0333
EN 1935:02
4 7 6 0 1 4 1 13

120 Kg

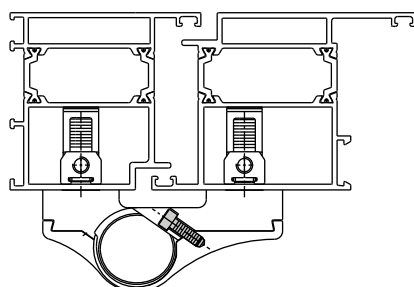
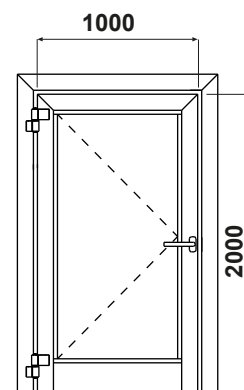

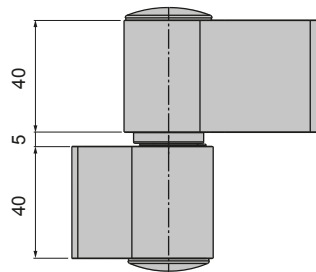
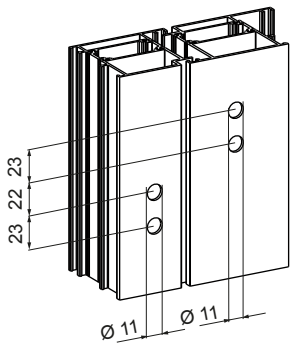
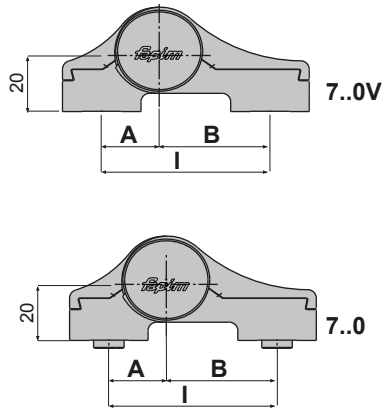

	I(mm)	A(mm)	B(mm)	LOIRA + V.	
7000	60	20.5	39.5		12
7000i	60	20.5	39.5		50
7000V	60	20.5	39.5	●	12
7000Vi	60	20.5	39.5	●	50
7010	67	20.5	46.5		12
7010i	67	20.5	46.5		50
7010V	67	20.5	46.5	●	12
7010Vi	67	20.5	46.5	●	50
7020	79	39.5	39.5		12
7020V	79	39.5	39.5	●	12
7030	80	20.5	59.5		12
7030V	80	20.5	59.5	●	12
7040	86	39.5	46.5		12
7040i	86	39.5	46.5		50
7040V	86	39.5	46.5	●	12
7040Vi	86	39.5	46.5	●	50
7050	93	46.5	46.5		12
7050i	93	46.5	46.5		50
7050V	93	46.5	46.5	●	12
7050Vi	93	46.5	46.5	●	50
7060	99	39.5	59.5		12
7060V	99	39.5	59.5	●	12
7070	106	46.5	59.5		12
7070V	106	46.5	59.5	●	12
7090	41	20.5	20.5		12
7090V	41	20.5	20.5	●	12

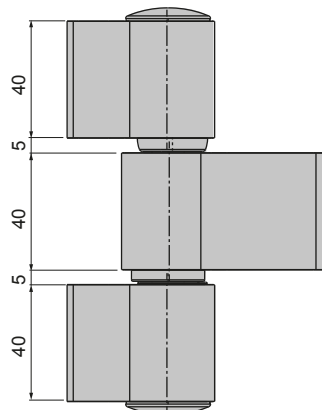
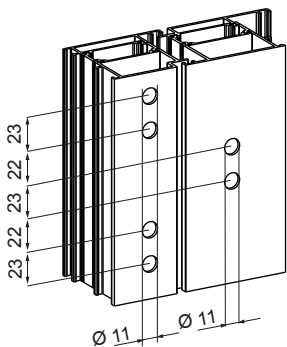
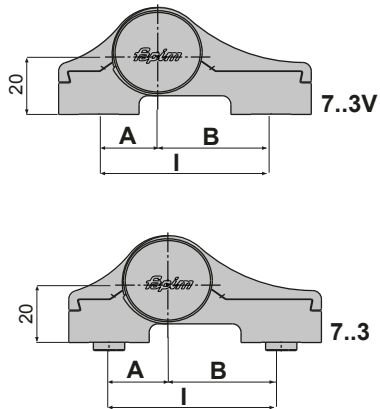

	I(mm)	A(mm)	B(mm)	LOIRA + V.	
7003	60	20.5	39.5		12
7003V	60	20.5	39.5	●	12
7013	67	20.5	46.5		12
7013i	67	20.5	46.5		50
7013V	67	20.5	46.5	●	12
7013Vi	67	20.5	46.5	●	50
7023	79	39.5	39.5		12
7023V	79	39.5	39.5	●	12
7033	80	20.5	59.5		12
7033V	80	20.5	59.5	●	12
7043	86	39.5	46.5		12
7043V	86	39.5	46.5	●	12
7053	93	46.5	46.5		12
7053V	93	46.5	46.5	●	12
7063	99	39.5	59.5		12
7063V	99	39.5	59.5	●	12
7073	106	46.5	59.5		12
7073V	106	46.5	59.5	●	12



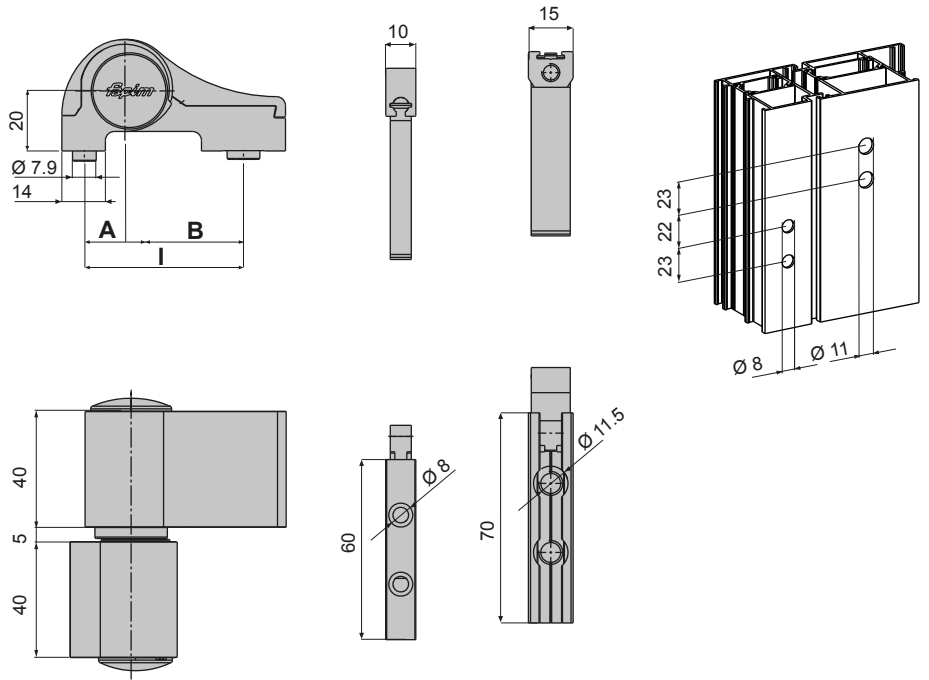

	I(mm)	A(mm)	B(mm)	
7100	53	13.5	39.5	12
7100i	53	13.5	39.5	50
7110	60	13.5	46.5	12
7120	73	13.5	59.5	12



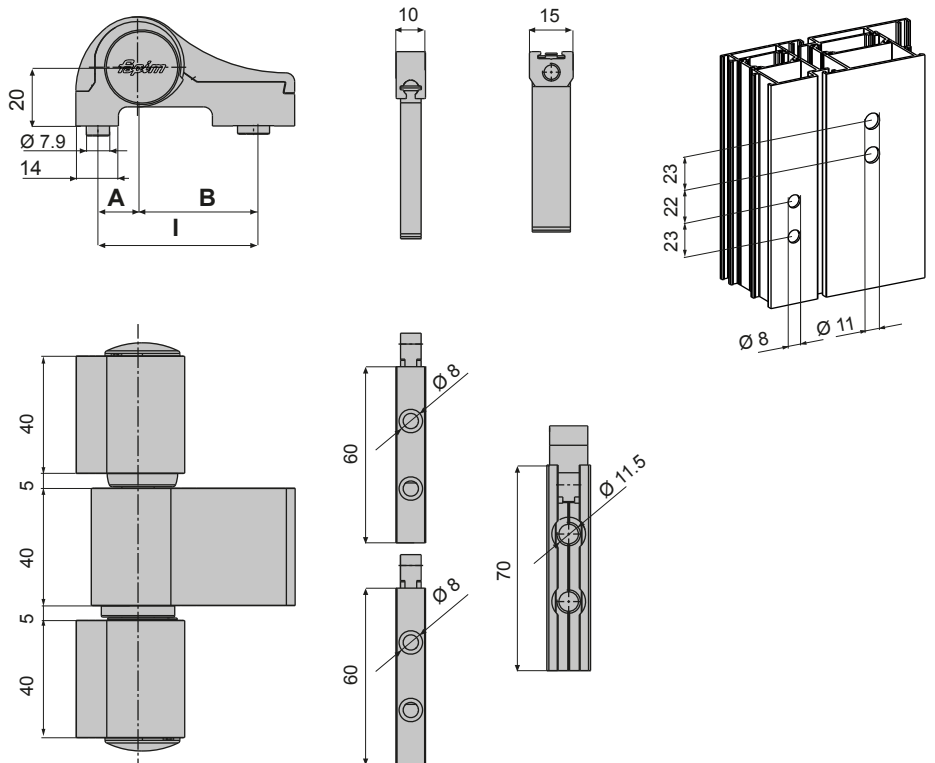

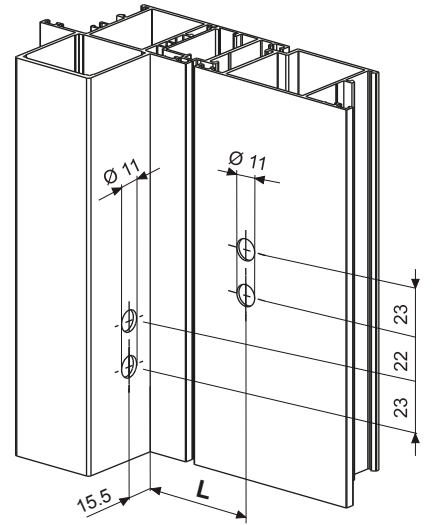
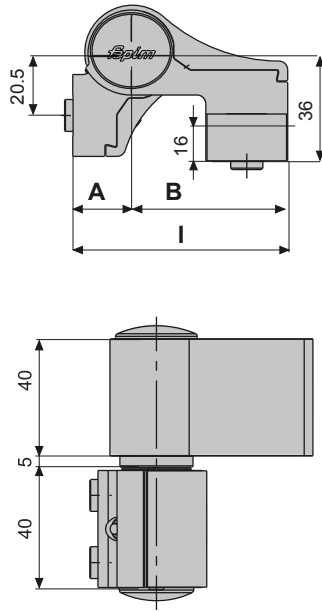
	I(mm)	A(mm)	B(mm)	
7103	53	13.5	39.5	12





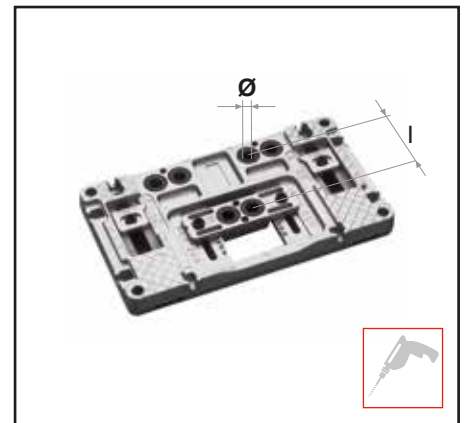
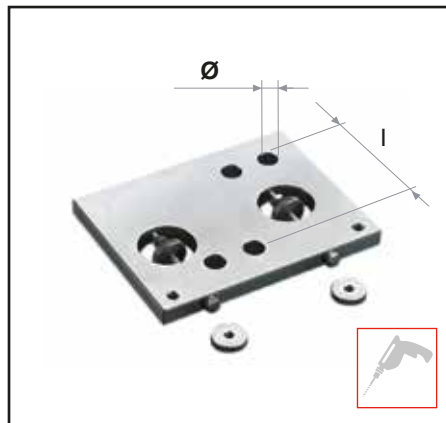

	I(mm)	A(mm)	B(mm)	
7130	60	20	40	12
7140	67	20	47	12



	I(mm)	
6885B	41-53-60-67-79 80-86-93-106	1

	I(mm)	Ø	
6842D	60	11	1
6842E	67		

	I(mm)	Ø	
6825	53-60-67 79-86-93	11	1
6825C		15	

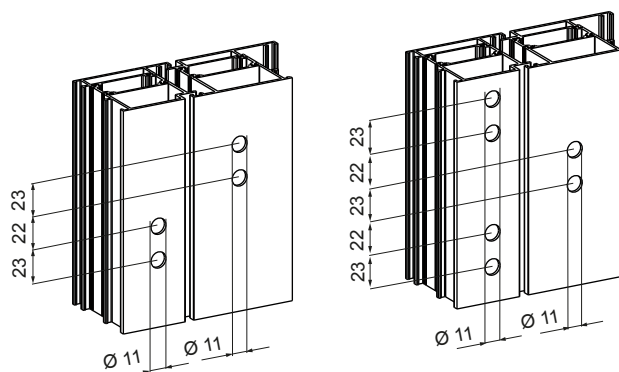

LOIRA +

LOIRA + V.

LOIRA +

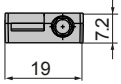

					LOIRA + V.	LOIRA +
6620Ai	●	●		100	●	
6620Ni	●			50		●
6621Ai		●		50	●	●
6621Ni	●			50		●

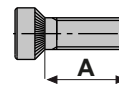
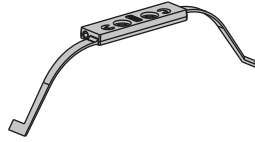
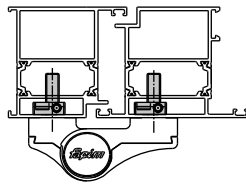

	A		LOIRA +
6663A	20	50	●
6663Bi	30	500	●
6663C	45	50	●
6663Di	60	500	●

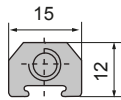

					LOIRA + V.	LOIRA +
6623	●			10		●
6625		●		10		●
6665AMi	●	●		100	●	●
6665CM		●		10	●	●

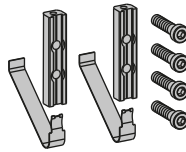
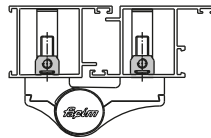

	A		LOIRA +
6679i	12-15	500	●
6681i	16.5-23	500	●
6682i	23-35	500	●
6683i	35-47	500	●

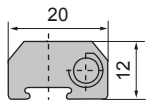

					LOIRA + V.	LOIRA +
6624	●			10		●
6626		●		10		●
6665BMi	●	●		100	●	●
6665DM		●		10	●	●

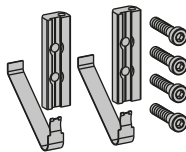
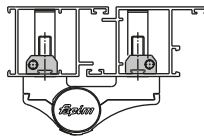

	A		LOIRA +
6679FAi	29.4	500	●
6679FBi	34.5	500	●

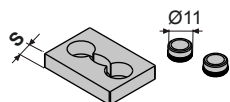

	S			LOIRA + V.	LOIRA +
6666S2	2		10	●	●
6666S4	4		10	●	●
6666S5	5		10	●	●
6666S7	7		10	●	●
6666S8	8		10	●	●
6666S85	8.5		10	●	●
6666S9	9		10	●	●
6666S10	10		10	●	●
6666T	16		12	●	●

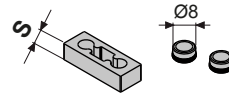
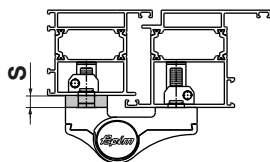

	S		LOIRA +
6669S2	2		10
6669S4	4		10
6669S5	5		10
6669S7	7		10
6669S8	8		10
6669S85	8.5		10
6669S9	9		10
6669S10	10		10

LOIRA + V.

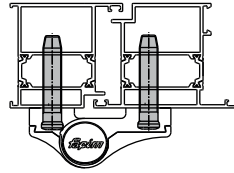
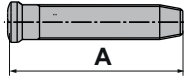
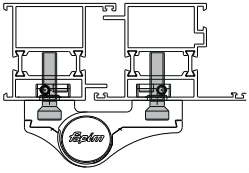

				A	LOIRA + V.	
6603A	●			12	50	●
6603B	●			12	50	●
6603i	●	●		100	50	●
6603Xi	●	●		100	50	●
6604A	●			12	60	●
6604B	●			12	60	●
6604i	●	●		100	60	●
6604Xi	●	●		100	60	●
6605A	●			12	76	●
6605B	●			12	76	●
6605i	●	●		12	76	●

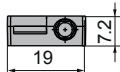
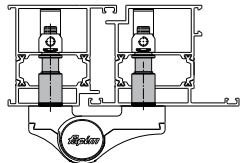

				A	LOIRA + V.
6620Vi	●			100	●
6621Vi	●			50	●

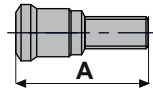
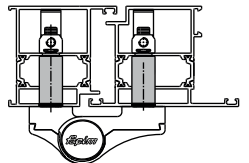
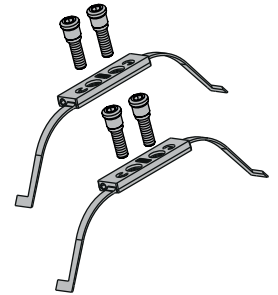
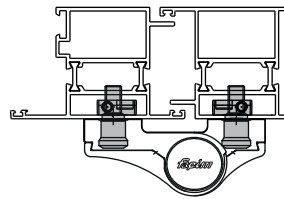

	A		LOIRA + V.
6663AV	30	50	●
6663BVi	40	500	●
6663CV	55	50	●
6663DVi	70	500	●

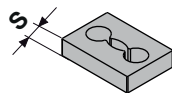
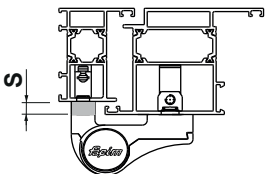
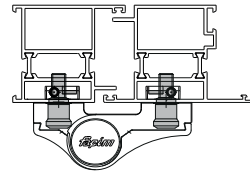

	S		LOIRA + V.
6607A	2	10	●
6607B	4	10	●
6607C	5	10	●
6607D	7	10	●
6607E	8	10	●
6607F	8.5	10	●
6607G	10	10	●
6607H	9	10	●
6607 T	16	12	●

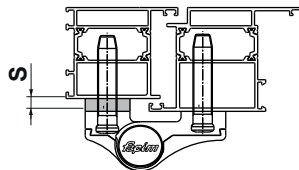

fapim[®]

Fapim S.p.A.
Via delle Cerbaie, 114
55011 Altopascio (LU) Italy
T +39 0583 2601 F+39 0583 25291
www.fapim.it info@fapim.it
Cod.Fisc. e Part.I.V.A. 02224030466

DOMATIC[®]

DOMATIC
info@domatic.it www.domatic.it

fapim

BENELUX

Fapim Benelux s.pr.l.b.v.b.a.
Avenue Rue St. Roch , 17
7712 Herseaux Belgium
T +32 56 340548
F +32 56 341960
info@fapimbenelux.be

fapim

HISPANIA

Fapim Hispania s.L.
C/edison, esq. A. Ingeniero
Goicoechea 45600
Parcela, 74
Talavera De la Reina (Espana)
T +34 925 828357
F +34 925 841148
administración@fapimhispania.com
pedidos@fapimhispania.com

fapim

POLSKA

Fapim Polska sp. z o.o.
ul.Przyrzeczze 4 03-107
WarszawaNIP : 536-16-29-437
T +48 227813797
F +48 227811022
Gsm 609022972

fapim

RUSSIA

Fapim RU llc
249010, Dom 33, Kievskoe Shosse,
Obninsk, Kaluga Region
Russian Federation
T +79 163116480

fapim[®]

ARGENTINA

Fapim Argentina S.A.
Buschiazzo N° 347
(1611) Don Torcuato
Partido de Tigre
Buenos Aires - Argentina
T +54 (11) 48463545